

PIATTA

AVVOLGIBILE IN ALLUMINIO

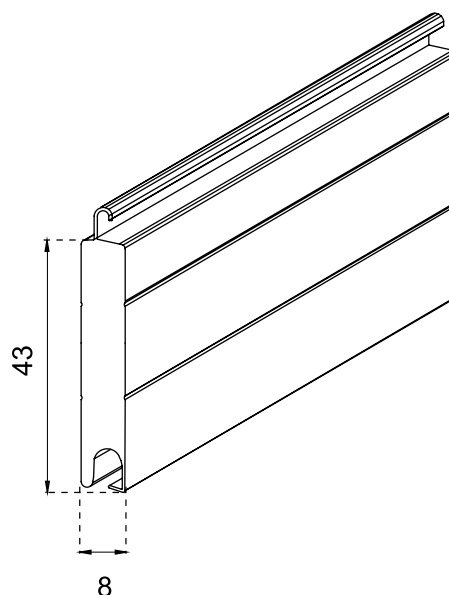

Profilo in alluminio piatto, design classico, con poliuretano.



PIATTA

Prodotto dalla forma insolita che pur soffrendo un ingombro ampio in rapporto alla sezione che presenta, offre maggiori garanzie per quanto concerne la resistenza e l'impatto estetico. Inoltre con il suo sistema box può essere impiegato per un montaggio esterno senza stravolgere il suo design.

Articolo	Tipologia	Specifiche tecniche	Um
PIATTA	Telo	in alluminio a Media Densità con terminale in PVC	ml
PIATTA CT	Telo	in alluminio a Media Densità con terminale in alluminio	ml

////////////////////////////////////
N.B. Minimo fatturabile: 1.50 mq

CARATTERISTICHE TECNICHE

Misura nominale 8x43 mm	Barre 1 m di altezza n.23,26	Peso telo/mq 2,90 Kg
----------------------------	---------------------------------	-------------------------

DIMENSIONI MAX VALIDE PER MARCATURA

RESISTENZA AL VENTO CLASSE 4

Larghezza massima 1,80 ml	Altezza massima 3,40 ml	Superficie massima 6,00 mq
------------------------------	----------------------------	-------------------------------

RESISTENZA AL VENTO CLASSE 5

Larghezza massima 2,50 ml	Altezza massima 3,40 ml	Superficie massima 6,00 mq	Trasmittanza termica W/m ² °K 4,35 U
------------------------------	----------------------------	-------------------------------	---

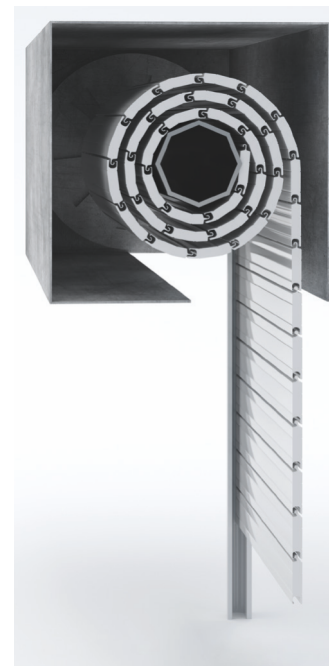



DIAMETRO DI ARROTOLAMENTO ► RULLO DA Ø 60

h 1000 Ø 150	h 1600 Ø 180	h 2200 Ø 195	h 2700 Ø 220
h 1300 Ø 155	h 1900 Ø 190	h 2500 Ø 215	h 3000 Ø 225

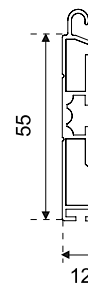
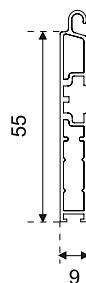
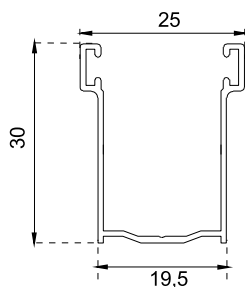
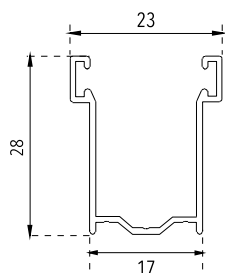
GUIDE E TERMINALI



ART. GE2817	ART. GE3019	ART. TERSMAC	ART. TER
Guida in alluminio	Guida in alluminio	Terminale in alluminio	Terminale in alluminio
 28x17 mm	 30x19.5 mm	 55x9 mm	 55x12 mm

N.B. Tabella colori a pag. 60